

Shark[®]

Steam and Scrub Mop

S6002 Series

INSTRUCTIONS





THANK YOU

for purchasing the Shark® Steam and Scrub Mop



 **TIP:** The QR Code can be found on the back panel of the Steam and Scrub Mop

REGISTER YOUR PURCHASE

-  sharkclean.co.uk/register-guarantee
-  0800 862 0453
-  Scan QR code using mobile device

To benefit from your product's extended guarantee, simply register your purchase at sharkclean.co.uk/register-guarantee

RECORD THIS INFORMATION

Model Number: _____
Date Code: _____
Date of Purchase (Keep receipt): _____
Store of Purchase: _____

TECHNICAL SPECIFICATIONS

Voltage: 220-240V~, 50/60Hz
Watts: 1120W

PLEASE READ CAREFULLY AND KEEP FOR FUTURE REFERENCE.

This instruction manual is designed to help you get a complete understanding of your new Steam and Scrub Mop. If you have any questions, please call the Customer Service line at 0800 862 0453.



CONTENTS

Important Safety Instructions	3
Getting Started	5
Assembling Your Steam and Scrub Mop	6
Using Your Steam and Scrub Mop	7
Intelligent Steam Control™	8
Caring For Your Steam and Scrub Mop	9
Ordering Additional Accessories	10
Troubleshooting Guide	11
Frequently Asked Questions	12
Guarantee	13



This marking indicates that this product should not be disposed with other household wastes throughout the UK. To prevent possible harm to the environment or human health from uncontrolled waste disposal, recycle it responsibly to promote the sustainable reuse of material sources. To return your used device, please use the return and collection systems or contact the retailer where this product was purchased. They can take this product for environmentally safe recycling.

Thank you for purchasing the Shark® Steam and Scrub Mop.

This Owner's Guide is designed to help you get a complete understanding of your new Steam and Scrub Mop. Please read it carefully and keep for future reference.

For a list of what is included with this model, refer to inside flap of box.

If you should have a question about your Shark® Steam and Scrub Mop please call Shark® Customer Service at 0800 862 0453.

IMPORTANT SAFETY INSTRUCTIONS

FOR HOUSEHOLD USE ONLY

⚠ WARNING This appliance is not intended for use by persons with reduced physical, sensory or mental capacities, or lack of experience and knowledge, unless they have been given supervision or instruction concerning use of the appliance by a person responsible for their safety. Children should not use or play with this appliance. Close supervision is necessary to keep appliance out of reach of children during use.

⚠ WARNING: Danger of scalding. The steam emitted from the steam mop is very hot and may cause scalding. Please use caution when using the steam and scrub mop.

⚠ WARNING: Keep steam mop away from children.

⚠ WARNING: Children should be supervised to ensure that they do not play with the appliance.

- 1 This appliance can be used by persons with reduced physical, sensory or mental capabilities or lack of experience and knowledge if they have been given supervision or instruction concerning use of the appliance in a safe way and understand the hazards involved. Cleaning and user maintenance should not be done by children. Keep the appliance and its cord out of reach of children. **DO NOT** allow to be used as a toy. Close supervision is necessary when used near children.
- 2 Keep the appliance out of reach of children when it is energised or cooling down.
- 3 When in use, **NEVER** turn the Steam and Scrub Mop over on its side or direct steam toward people, pets or plants. Liquid or steam must not be directed towards equipment containing electrical components, such as the interior of ovens.

- 4 The filling aperture should not be opened during use.
- 5 Use the system **ONLY** for its intended purpose.
- 6 **DO NOT** use to heat a room.
- 7 **DO NOT** use outdoors.
- 8 **DO NOT** leave the Steam and Scrub Mop unattended when plugged in. **ALWAYS** unplug the power cord from the electrical socket when not in use and before servicing.
- 9 **DO NOT** allow the Steam and Scrub Mop to be used by children. Close attention is necessary when used near children, pets or plants.
- 10 Use **ONLY** as described in this instruction manual.
- 11 Use **ONLY** manufacturer's recommended accessories.
- 12 **DO NOT** use with damaged cord or plug. If the Steam and Scrub Mop is not working as it should or has been dropped, damaged, left outdoors or immersed in water, return it to SharkNinja Europe Limited for examination and repair. Incorrect reassembly or repair can cause a risk of electrical shock or injury when the Steam and Scrub Mop is used.
- 13 To protect against a risk of electric shock, **DO NOT** immerse the Steam and Scrub Mop in water or any other liquid.
- 14 **DO NOT** handle the plug or Steam and Scrub Mop with wet hands or operate it without wearing shoes.

SAVE THESE INSTRUCTIONS

PLEASE READ CAREFULLY BEFORE USE

- 15 **DO NOT** pull or carry by cord, use cord as a handle, close a door on cord or pull cord around sharp edges or corners. **DO NOT** run Steam and Scrub Mop over cord. Keep cord away from heated surfaces.
- 16 **DO NOT** unplug by pulling on power cord. To unplug, grasp the plug and pull out of the plug socket. **DO NOT** use extension cords or sockets with inadequate current-carrying capacity.
- 17 **DO NOT** put any objects into the steam nozzle openings. Discontinue use if the steam nozzle is blocked.
- 18 **DO NOT** put hands or feet under the Steam and Scrub Mop as it gets very hot.
- 19 Use the Steam and Scrub Mop **ONLY** on flat, horizontal surfaces. **DO NOT** use on walls, counters or windows.
- 20 **DO NOT** use on leather, wax-polished furniture, synthetic fabrics, velvet or other delicate, steam-sensitive materials.
- 21 **DO NOT** add cleaning solutions, vinegar, scented perfumes, oils or any other chemicals to the water used in the Steam and Scrub Mop. This may damage the mop or make it unsafe for use. If you live in a hard-water area, we recommend using distilled water in your Steam and Scrub Mop.
- 22 **NEVER** store or leave Steam and Scrub Mop in one spot with Dirt Grip™ pad attached, as this may damage surfaces.
- 23 Before removing Dirt Grip™ pad, unplug the Steam and Scrub Mop and allow it to cool.
- 24 Unplug the Steam and Scrub Mop before cleaning. Use a dry or damp cloth to clean the exterior. **DO NOT** pour water on Steam and Scrub Mop or use alcohol, benzene or paint thinner to clean.
- 25 Extreme caution should be exercised when using the Steam and Scrub Mop to clean stairs.
- 26 **NEVER** use Steam and Scrub Mop without the Dirt Grip™ pad attached.
- 27 Keep your work area well lit.
- 28 Store Steam and Scrub Mop indoors in a cool, dry place.
- 29 To avoid circuit overload, **DO NOT** operate another appliance on the same socket (circuit) as the Steam and Scrub Mop.
- 30 To avoid scalding injuries, **ALWAYS** unplug the Steam and Scrub Mop and allow it to cool before removing or changing mop heads, accessories or Dirt Grip™ pads.
- 31 Your Steam and Scrub Mop is designed to clean hard floor surfaces that will withstand high heat. **DO NOT** use on unsealed wood or unglazed ceramic floors. On surfaces that have been treated with wax and on some no-wax floors, the sheen may be removed by the heat and steam action. We recommend that you check the use and care instructions from the floor manufacturer before using your Steam and Scrub mop. Do not operate the appliance if it is leaking.

GETTING STARTED

When assembling your steam mop there may be a little water in or around the water tank. This is because we test all our steam mops before you buy them, so you get a quality **Shark® Steam and Scrub Mop**.

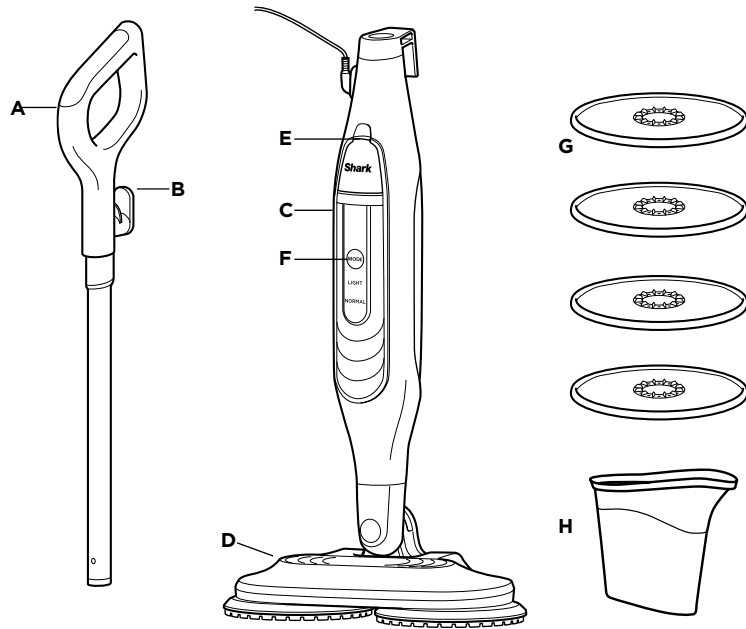

- A Steam Mop Handle
- B Quick-Release Cord Holder
- C Steam Mop Body
- D Floor head

- E Water Tank Lid
- F Mode Button
- G Dirt Grip™ Pads
- H Filling Flask

ASSEMBLING YOUR STEAM AND SCRUB MOP

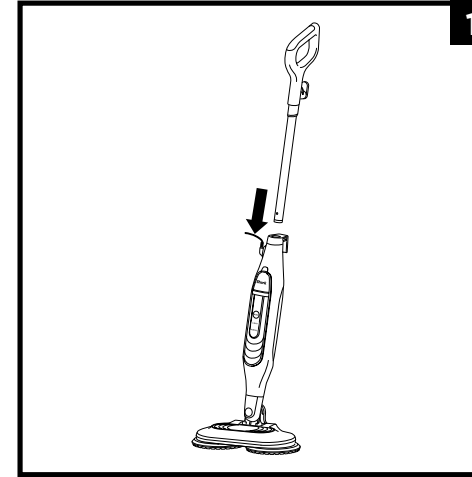

- 1 Insert the mop handle into the steam mop body until it clicks into place.

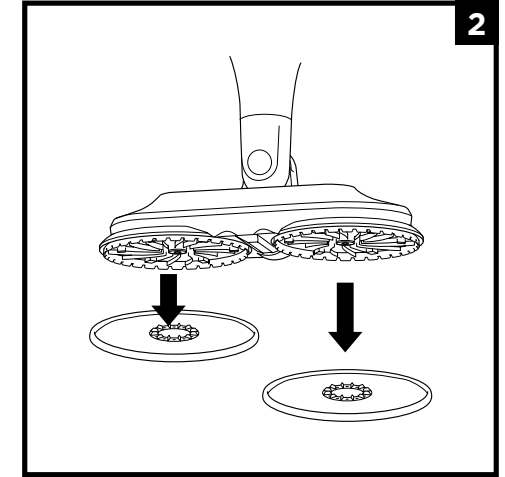

- 2 To attach the Dirt Grip™ pads, place **BOTH** the pads flat on the floor with the plastic rings facing up. Align the indentation on the rotating discs on the bottom of the nozzle with the plastic rings on the pads, then gently lower the nozzle onto the pads, pressing until the pads are secured.

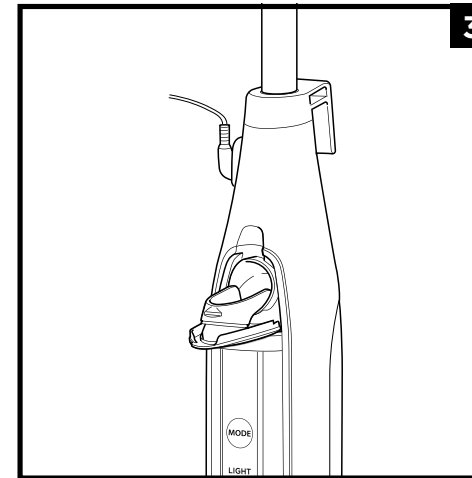

- 3 To open the water tank, pull the lid down.

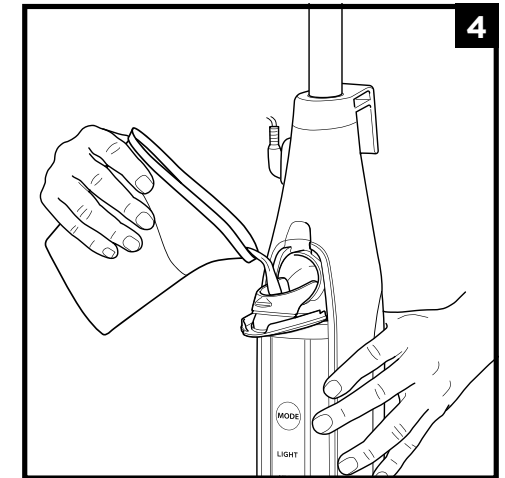

- 4 Use the filling flask to pour distilled water into the tank. Make sure to not exceed the Max Fill line on the flask. When finished, close the tank lid firmly.

NOTE: Max capacity of the water tank is 320ml

USING YOUR STEAM AND SCRUB MOP

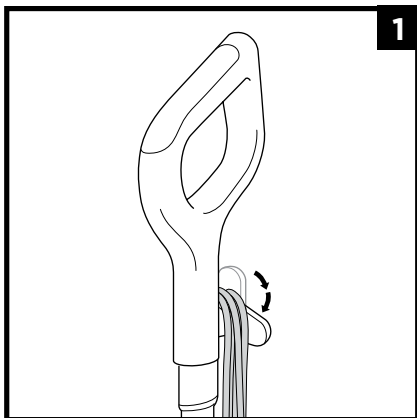

- 1** Make sure that your pads are secured to the nozzle discs.
Twist the quick-release cord holder to unwrap the power cord completely. Plug into an electrical socket.

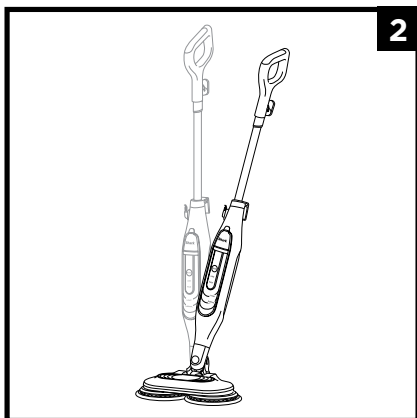

- 2** To start cleaning, put your foot on the floor head and pull the handle towards you. This will engage the power pads
Please note, if the handle is not reclined within 30 seconds of selecting a mode the mop goes back into standby.

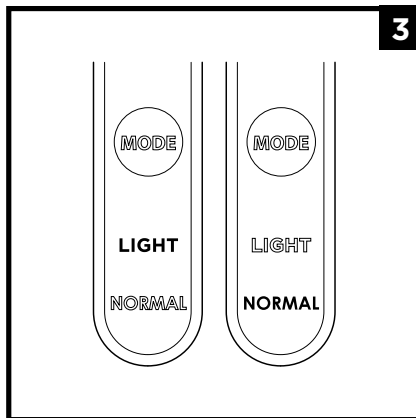

- 3** When the mop is first plugged in, the unit will be in Standby Mode and 2 Indicator Lights will blink. Using the mode button select your preferred setting.
- 4** Mop with a forward and backward motion.
- 5** When the water tank is empty, the steam mop will stop producing steam. Make sure the unit is unplugged before refilling the water tank.
- 6** When finished mopping, press the mode button. The blue light will blink, indicating that the unit is in Standby mode. Once in Standby mode, lift the handle to bring the steam mop back to the upright position and unplug the unit.
- 7** Please wait 2 to 3 minutes for the steam mop to cool completely before removing the Dirt Grip™ pads.
Never leave the steam mop with damp or wet Dirt Grip™ pads on any floor for an extended period.

TIP: When cleaning near skirting boards, edges, or furniture, you may feel a slight pull from the unit making contact with surfaces. This is normal and not a cause for concern.

NOTE: If the handle is not reclined the pads do not spin.

NOTE: To prolong the life of your steam mop, we recommend using distilled water.

NOTE: Sweep or vacuum your floors prior to cleaning with your steam mop.

NOTE: Both pads must be installed at all times during use.

INTELLIGENT STEAM CONTROL™

The **Shark® Steam and Scrub Mop** has 2 unique Intelligent Steam Control settings so you can select the ideal amount of steam to use for each cleaning task. In **NORMAL MODE**, the pads will spin faster and more steam will be produced. See below for tips on when to use each setting.

SETTING	IDEAL FOR THESE SEALED SURFACES	RECOMMENDED USAGE
LIGHT 	Laminate Hardwood Vinyl	Cleaning delicate surfaces Light cleaning and dusting Loosening and lifting light dirt
NORMAL 	Marble Tile Stone	Basic, everyday cleaning Cleaning large areas Cleaning moderate and heavy traffic areas

TO SANITISE*:

- 1 Attach clean Dirt Grip™ pads to the scrubbing nozzle.
- 2 Plug in the unit, tilt the mop handle down towards you, and press the mode button to select the **NORMAL** setting. The pads will then start spinning.
- 3 Wait 30 seconds for the unit to begin producing steam.
- 4 Start mopping with a forward and backward motion on an appropriate sealed hard floor surface. After three minutes, your unit will be ready to sanitise.
- 5 Using a forward and backward motion, move the unit slowly and evenly over the area to be sanitised while applying continuous downward pressure. Slowly repeat at least 8 times.

*Sanitisation studies were conducted under controlled test conditions. Household conditions and results may vary. With scrubbing nozzle in **NORMAL** mode.

CARING FOR YOUR STEAM AND SCRUB MOP

AFTER USE AND STORAGE

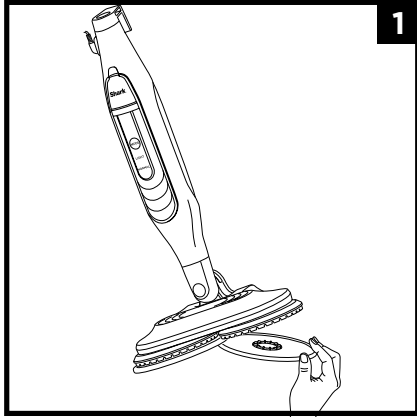

- 1** When the pads have cooled completely, remove them by pulling them off the discs.

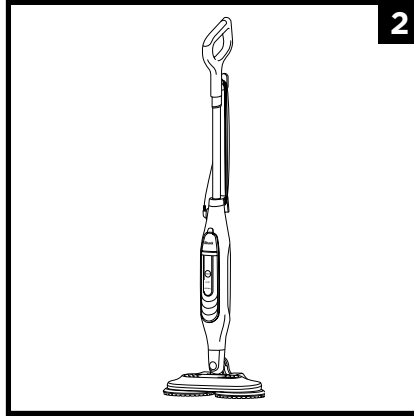

- 2** After the unit has cooled and the steam has been released, empty the water tank before storing. Open the tank lid and pour the water out into a sink or bathtub. After all the water has drained out, close the lid.
- 3** To store the steam mop, wait until after it has cooled and the steam has been released. Store steam mop in a dry protected area until next use.

Dirt Grip™ PAD CARE INSTRUCTIONS



Machine-wash the Dirt Grip™ pads separately with warm water using liquid detergent.

NEVER USE BLEACH, POWDERED DETERGENT, OR FABRIC SOFTENERS

as they may damage the Dirt Grip™ pads or leave a coating that will reduce their cleaning performance and absorbency. Dirt Grip™ pads should be line-dried or tumble-dried on a low setting, as this will extend the life of the microfibre fabric.

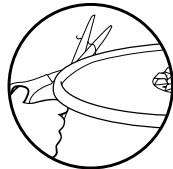

Loose fibres can indicate wearing of the microfibre fabric. **DO NOT** pull the loose fibres as this can cause the weave to come undone. Simply trim the loose fibres with scissors.

Replacement Dirt Grip™ pads

For best cleaning results, we recommend replacing the Dirt Grip™ pads every 3 to 4 months following normal use. As with any fabric, dirt particles, grease, friction, and repeated washing can cause the fibres to break down, and you may notice an increase in the effort needed to push or pull the mop.

ORDERING ADDITIONAL ACCESSORIES

ACCESSORY

Filling Flask

Makes it simple and convenient to fill the water tank.



Dirt Grip™ Pads

Easy-to-attach, reusable pads feature a super-absorbent microfibre for locking in moisture and dirt, and scrubbing material for breaking up tough, stuck-on stains.



You can purchase replacement Dirt Grip™ pads and other accessories by visiting sharkclean.co.uk.

TROUBLESHOOTING

PROBLEM	POSSIBLE REASONS & SOLUTIONS
The steam mop isn't producing any steam.	<p>The steam mop should be securely plugged into an electrical socket. Check your fuse or circuit breaker or try a different socket.</p> <p>Make sure the water tank is full, the unit is plugged in, and the mode button is illuminated.</p> <p>If the indicator lights are off, try a different electrical socket.</p> <p>If the indicator lights are blinking, press the mode button to select a steam setting.</p> <p>If the indicator lights are solid, wait 30 seconds for the unit to warm up.</p> <p>If after following the above steps the steam mop still does not produce any steam, contact Customer Service at 0800 862 0453 or visit sharkclean.co.uk</p>
The steam mop is producing intermittent steam.	<p>This is normal. For more consistent steam, select the NORMAL setting. Also make sure the water tank is full.</p>
I can't select a steam setting.	<p>Make sure the steam mop is plugged in and the indicator lights are flashing.</p> <p>If your steam mop is producing steam but the indicator lights are off, call customer service at 0800 862 0453.</p>
Floors are cloudy, streaky, or spotty after steaming.	<p>The Dirt Grip™ pads might be dirty. Install a clean set of pads. If you washed the Dirt Grip™ pads with powdered detergent, then they could be damaged and require replacement.</p> <p>Due to accumulated soap or grease residue, the floor may require several cleanings with the Steam Mop.</p> <p>A more stubborn case may require you to rinse the floor with a mix of one part vinegar and two parts water* (but DO NOT put any cleaning solution into the steam mop's water tank).</p> <p>*Please consult your flooring manufacturer's care and maintenance instructions before applying any cleaning products or solutions.</p>
It's hard to push or pull the mop.	<p>The mop might be hard to push or pull if the Dirt Grip™ pads aren't wet enough. It should get easier to move the mop across the floor after it's been running for a few minutes.</p> <p>Overly dirty pads could also make it harder to push or pull the mop. We recommend using clean pads.</p>
Rotating discs are not turning or are wobbling.	<p>The steam mop may be in the upright position. Tilt the handle down to use the mop.</p> <p>The Dirt Grip™ pads may not be centred. Turn the power OFF, unplug the steam mop, wait for a few moments to allow the pads to cool, then reinstall the Dirt Grip™ pads.</p>
The steam mop is vibrating or wobbling.	<p>The Dirt Grip™ pads are not centred on the rotating discs. Turn the power OFF and unplug the unit, and wait for the pads to cool. Follow the instructions in the Assembling Your Steam and Scrub Mop section to reinstall the pads.</p>
The Steam and Scrub Mop turns off on its own.	<p>If your Steam and Scrub mops shuts off in use, it likely needs to cool down. Perform the following steps before you restart cleaning.</p> <p>Unplug it and remove the pads.</p> <p>Allow the unit to cool for a minimum of 30 minutes.</p> <p>Reinstall the pads. Plug in the Steam and Scrub mop, select your steam mode and begin cleaning.</p>

FAQ

QUESTION	ANSWER
Can I use the steam mop on carpets?	<p>No, the steam mop is not designed for carpet cleaning.</p>
What surfaces can I use the steam mop on?	<p>The steam mop is designed for use on all sealed hard floor surfaces. We recommend consulting the use and care instructions from your floor manufacturer before using your Steam and Scrub Mop.</p> <p>▲ WARNING: DO NOT use on leather, wax-polished furniture, synthetic fabrics, velvet, or other delicate, steam-sensitive materials.</p> <p>NOTE: On surfaces treated with wax and on some unwaxed floors, the sheen may be removed by the heat or steam action of the unit.</p>
Can I put something other than water in the water tank of the steam mop?	<p>DO NOT add cleaning solutions, vinegar, scented perfumes, oils, or any other chemicals to the water used in this appliance, as this may damage the unit or make it unsafe for use. We recommend using distilled water in your steam mop.</p>



NOTE: Save these instructions. Keep for future reference.

**SharkNinja Europe Limited,
3150 Century Way, Thorpe Park,
Leeds, LS15 8ZB, UK
+44 (0)800 862 0453
www.sharkclean.co.uk**

**SharkNinja Germany GmbH
c/o Regus Management GmbH,
Excellent Business Center 10
+11/Stock, Westhafenplatz 1,
60327 Frankfurt am Main, Germany
www.sharkclean.eu**

Illustrations may differ from actual product. We are constantly striving to improve our products, therefore the specifications contained herein are subject to change without notice.

© 2021 SharkNinja Europe Limited.
SHARK is a registered trademark of SharkNinja Operating LLC.

DIRT GRIP and INTELLIGENT STEAM CONTROL are trademarks of SharkNinja Operating LLC.

S6002UK Series_IB_MP_210607_MV1
PRINTED IN CHINA

